



SimpliFire[®]
Fire Made Simple

Electric

Linear Electric Fireplaces

Show-stopping designs in a clean finish

SCION TRINITY

- Visually striking multisided design
- Install as three-sided (bay), two-sided (left- or right-corner), or single-sided
- Cleanest finish with concealed heat vents
- Tall, 15-inch high viewing for impactful room presence
- Extra-deep ember bed for an impressive media display
- Clear crystal media and driftwood logs with glowing embers come standard

BEST

Controls

- Buttons conveniently located on the face of the fireplace
- Standard multi-functional remote turns the fireplace on and off and controls the thermostat, flame and ember bed colors

Optional Accessories

- Floating mantel kit (for wall mount applications)
- ShadowGlo™ high-definition log sets



SCION

- Cleanest finish with concealed heat vents
- Tall, 15-inch high viewing for impactful room presence
- Extra-deep ember bed for an impressive media display
- Clear crystal media and driftwood logs with glowing embers come standard

BEST

Controls

- Buttons conveniently located on the face of the fireplace
- Standard multi-functional remote turns the fireplace on and off and controls the thermostat, flame and ember bed colors

Optional Accessories

- ShadowGlo™ high-definition log sets

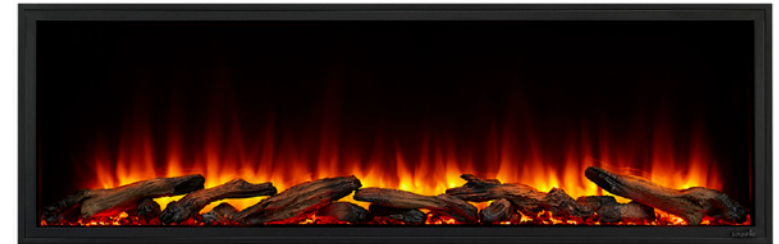

FORUM OUTDOOR

- Durable to withstand the elements
- Clean look with finishing materials to the edge or framed with included overlap front
- Clear crystal media and driftwood logs with glowing embers come standard

BEST

Controls

- Buttons conveniently located on the face of the fireplace
- Standard multi-functional remote turns the fireplace on and off and controls the thermostat, flame and ember bed colors

Optional Accessories

- ShadowGlo™ high-definition log sets



Match a stunning SimpliFire® linear electric fireplace to your design vision. Add year-round ambiance to any space in your home, in styles from wall mount to built-in, in single-sided, corner or three-sided configurations where you can finish your wall in a sleek look.

BETTER

ALLUSION PLATINUM

- Tall, 15-inch high viewing area with minimal frame
- Installs flush into a 2x6 wall, maximizing floor space
- Clear crystal and ceramic white stone media come standard

Controls

- Buttons conveniently located on the face of the fireplace
- Standard multi-functional remote turns the fireplace on and off and controls the thermostat, flame and ember bed colors

Optional Accessories

- Driftwood log set to enhance the allure
- Wall-mount kit available for quick and easy installation in any room



GOOD

ALLUSION SLIM – NEW!

- Flexibility, with an ultra-thin design, to recess fully into a 2x4 wall or mounted using the optional Crestline wall mount surround
- Clear and black crystal media, as well as logs, come standard

Controls

- Buttons conveniently located on the face of the fireplace
- Standard multi-functional remote turns the fireplace on and off and controls the thermostat, flame and ember bed colors

Optional Accessories

- Crestline wall mount surround kit for the 50" and 60" models with a painted white shiplap finish



GOOD

FORMAT

- Clean, built-in look in an easy-to-install wall mount design
- Clear crystal media and one-piece ShadowGlo Alpine Timber log set come standard

Controls

- Buttons conveniently located on the face of the fireplace
- Standard multi-functional remote turns the fireplace on and off and controls the thermostat, flame and ember bed colors



Scion Trinity

Create an alluring atmosphere from any angle with the SimpliFire Scion Trinity electric fireplace. In three-sided, corner, or single-sided configurations, it adds stunning ambiance without the need for gas lines or venting.

Features

- Bring finishing materials right to the edge of the fireplace for a flush, built-in look
- No mesh screen or visible heat vents
- Accent lighting for greater warmth and ambiance
- Clear crystal media and driftwood logs with glowing embers come standard
- Available in 43" and 55" models
- Control with buttons on the face of the fireplace or with the standard multi-functional remote



Scion Trinity 55" with Driftwood logs

Included media



Clear crystals

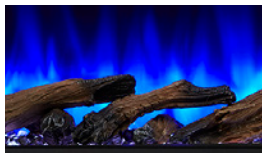

Driftwood logs

Optional ShadowGlo log sets



Alpine Timber logs



Natural Birch logs



Scion Trinity 55" with floating mantel kit



Scion Trinity 43" with Driftwood logs



Scion

Distinctly express your style. Seamlessly finish your wall and bring materials right to the edge of the fireplace for sleek look. Concealed vents, dynamic flame and vibrant lights bring your room to life, clean and simple.

Features

- Bring finishing materials right up to the edge of the fireplace for a flush, built-in look
- No mesh screen or visible heat vents
- Accent lighting for greater warmth and ambiance
- Clear crystal media and driftwood logs with glowing embers come standard
- Available in 43", 55", and 78" wide models
- Control with buttons on the face of the fireplace or with the standard multi-functional remote



Scion 55" linear shown with orange flame and Driftwood logs

Scion Linear Series

Included media



Clear crystals

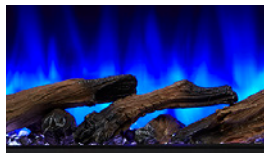

Driftwood logs

Optional ShadowGlo log sets



Alpine Timber logs



Natural Birch logs



Scion 78" shown with blue flame and Clear Crystals

Allusion Platinum

Creating an elegant focal point in your home has never been easier. Designed with comfort and ambiance in mind, the Allusion Platinum provides an impressive viewing area within a minimal frame.

Features

- Clear crystal media and ceramic white stones come standard
- Available in 50", 60", and 72" wide models
- Flexible installation: Fully recess for a flush look, or surface-mount with the optional wall-mount kit
- Optional non-structural Boyd Build-Out kit; 50" model only
- Control with buttons on the face of the fireplace or with the standard multi-functional remote



Wall Mounted

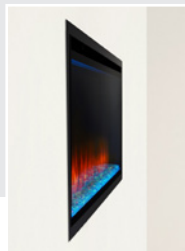

Fully Recessed

Included media



Clear crystals



Ceramic white stones



Driftwood Logs

Optional media

Optional Boyd Build-Out Kit



For our 50" model, choose to finish with the optional Boyd build-out kit. It's a simple addition for big impact, giving you a built-in look without any need for construction. Choose modern Farmhouse white shiplap or a ready-to-finish design.



Allusion Platinum 60" linear shown with blue flame and ceramic white stones



Allusion Platinum 50" shown with Optional Boyd Build-Out Kit - Modern Farmhouse Style

Allusion Slim – NEW!

The Allusion Slim electric fireplace beautifully bridges expert technology and style. The ultra-thin, four-inch depth is one of the slimmest in the market, making it easy to recess or wall-mount almost anywhere. Create your perfect fire -- with or without heat -- from the comfort of your couch.

Features

- Four lengths -- 40", 50", 60", 72" offers a solution for any rooms and pairs perfectly with the most popular TV sizes
- Ultra-thin design enables a flush installation into a 2x4 wall
- Nine flame colors, five brightness settings, 13 ember bed colors
- Clear crystals, black crystals and logs ship standard
- Timer and thermostat included
- 5,000 BTUs of heat generated through hidden vents
- May be hardwired or plugged into wall outlet
- Control with buttons on the fireplace or with standard remote
- LED readout displays selected settings
- Optional Crestline wall mount surround available for 50" and 60" models with painted white finish



Allusion Slim 50" shown with logs and optional Crestline wall mount surround

Allusion Linear Series

ALLUSION SLIM
Electric Fireplace

SimpliFire



4 size options: 40", 50", 60" or 72"
12" high viewing area
Year-round comfort with or without heat

Black Crystal Media (included) Clear Crystal Media (included) Logs (included)

FLEXIBLE
Install Almost Anywhere

SimpliFire



✓ No Gas Line or Venting
✓ Can Be Recessed into 2x4 Wall
✓ Safe For Rentals

INSTALLATION
Choose Your Look

SimpliFire

Fully Recessed in 2x4 framing Wall Mounted hardware included Wall Mounted with Crestline cabinet (optional)



Three Easy Options

MODERN FOCAL POINT
Easy To Install

SimpliFire



The optional Crestline Wall Mount Surround Kit gives the appearance of a built-in electric fireplace without the need for construction.

Format

We all desire simplicity in everyday life. The SimpliFire Format wall-mounted electric fireplace is the easiest way to add a modern centerpiece to any space. The minimalist floating-mantel design, available in several lengths, fits your décor with multi-colored accent lighting to set the mood.

Features

- Minimalist floating mantel provides a clean, built-in look in an easy wall-mount design
- Available in 43", 50" and 60" sizes
- No mesh screen or visible heat vents
- Clear crystal media and ShadowGlo Alpine Timber log set come standard
- Enjoy year-round with or without heat
- Easy control with the intuitive, multifunction remote
- Control with buttons on the face of the fireplace or with the standard multi-functional remote

Included media



ShadowGlo Alpine Timber log set



Clear crystals



Format 50" linear shown with ShadowGlo Alpine Timber log set



Format 43" shown with orange flame and Clear Crystals

Forum Outdoor

The SimpliFire Forum outdoor electric fireplace is the easiest way to turn your patio or deck into a go-to oasis. Designed for outdoors and with the flexibility to place it anywhere, the Forum expands your livable area with freedom from propane tanks, gas lines or wood.

Features

- Big presence in 43" and 55" linear sizes
- Durable to withstand the elements
- Clean look with finishing materials to the edge or framed with included overlap front
- Four flame and 13 ember-bed colors to fit your mood
- Pick the look you want, from clear crystals or driftwood logs with glowing embers
- No heat allows you to safely place a TV or artwork directly above your fireplace
- Easy remote control

Included media



Clear crystals



Driftwood logs

Optional ShadowGlo log sets



Alpine Timber logs



Natural Birch logs



Forum 55" outdoor linear built-in (frameless look without front) with Crystal media

Forum Linear Series - Outdoor



Forum 55" outdoor linear recessed (with self-trimming front) shown with Driftwood logs

Linear Electric Fireplace Features and Options

Model	Scion Trinity 43", 55"	Scion 43", 55", 78"	Allusion Platinum 50", 60", 72"	Allusion Slim 40", 50", 60", 72"	Format 43", 50", 60"	Forum Outdoor 43", 50"
Flame Colors	4	4	4	9	4	4
Ember Bed Colors	13	13	13	13	13	13
Accent Lighting	YES	YES	NO	NO	YES - Multi-Colored	YES
Remote	YES	YES	YES	YES	YES	YES
Thermostat Mode	YES	YES	YES	YES	YES	NO
Included Media	-Clear Crystals -Driftwood Logs	-Clear Crystals -Driftwood Logs	-Clear Crystals -Ceramic White Stones	-Clear Crystal Media -Black Crystal Media -Logs	-Clear Crystals -ShadowGlo Alpine Timber log set (one-piece)	-Clear Crystals -Driftwood Logs
Optional Media	ShadowGlo™ Logs: -Alpine Timber -Natural Birch	ShadowGlo Logs: -Alpine Timber -Natural Birch	-Driftwood Logs	N/A	N/A	ShadowGlo™ Logs: -Alpine Timber -Natural Birch
Installation Method	-Built-In 3-Sided (Bay) -Built-In 2-Sided (L/R Corner) -Built-In Single-Sided -Wall Mount (with optional floating mantel kit)	-Built-In Flush	-Fully Recess 2x6 Framing -Wall Mount (with optional kit)	-Recessed Flush in 2x4 Framing -Wall Mount with optional Crestline wall mount surround kit; 50" and 60" models only	-Wall Mount	-Built-In Flush -Built-In with Overlap Front
Electrical Connection	-15 AMP, 120V/60 Hz -Hardwire or Plug-In	-15 AMP, 120V/60 Hz -Hardwire Only	-15 AMP, 120V/60 Hz -Hardwire or Plug-In	-15 AMP, 120V/60 Hz -Hardwire or Plug-In	-12.5 AMP, 120V/60 Hz -Hardwire or Plug-In	-15 AMP, 120V/60 Hz -Hardwire or Plug-In
Heat Output	Up to 5,000 BTUs; 1,500W High/750W Low	Up to 5,000 BTUs; 1,500W High/750W Low	Up to 5,000 BTUs; 1,500W High/750W Low	Up to 5,000 BTUs; 1,500W High/750W Low	Up to 5,000 BTUs; 1,500W High/750W Low	N/A

Thirteen ember bed colors

Ember beds are lit with the glow from long-lasting LED lights and provides 13 individual color options as well as the option to continuously rotate through all the colors.

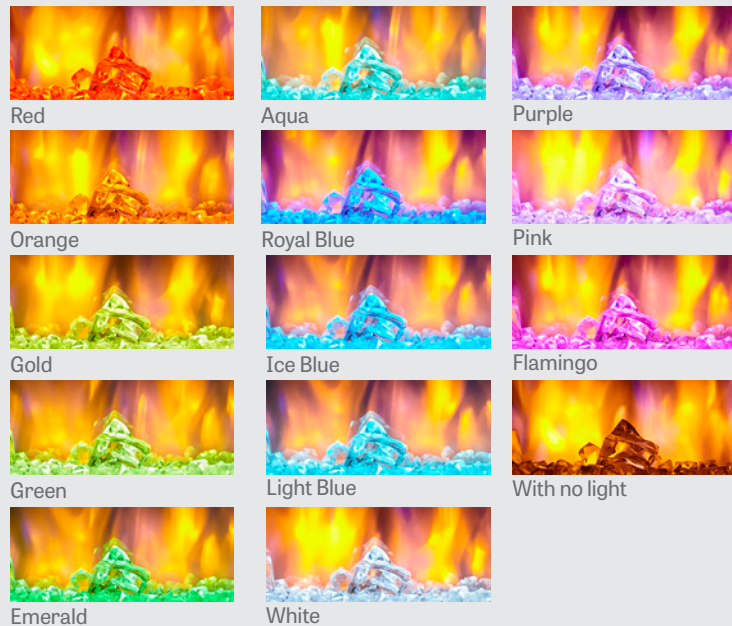

Up to nine flame colors

LED flame technology delivers enhanced energy efficiency with up to nine colors depending upon model.

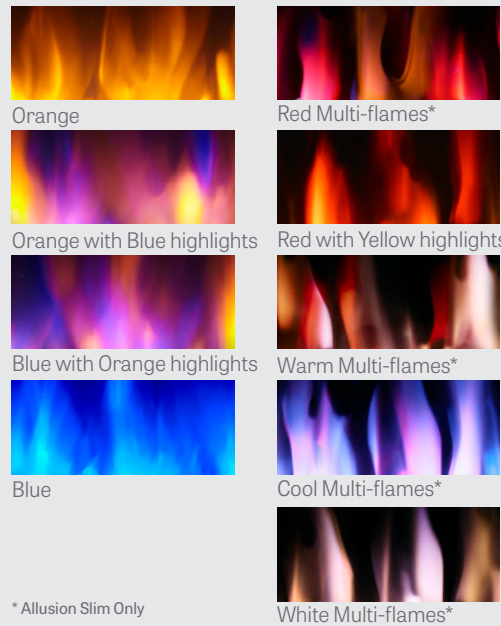

* Allusion Slim Only

Multi-Function Remote

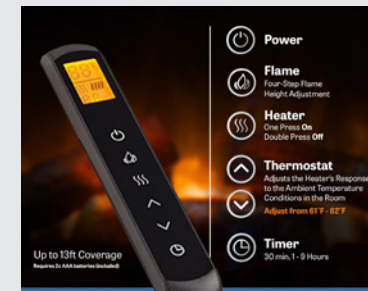

Allusion Slim Remote



Scion Trinity



Model	BTU Output	Width (A)		Height (B)		Depth (C)		Viewing Area (D x E)
		Unit	Framing	Unit	Framing	Unit	Framing	
SF-SCT43-BK	5,000	42-1/2" [1080]	42-3/4" [1086]	22-1/4" [565]	22-5/8" [575]	11-1/4" [286]	11-1/2" [194]	42-1/2" x 14-3/4" [1080 x 375]
SF-SCT55-BK	5,000	54-1/2" [1384]	54-5/8" [1387]	22-1/4" [565]	22-5/8" [575]	11-1/4" [286]	11-1/2" [194]	54-1/16" x 14-3/4" [1373 x 375]

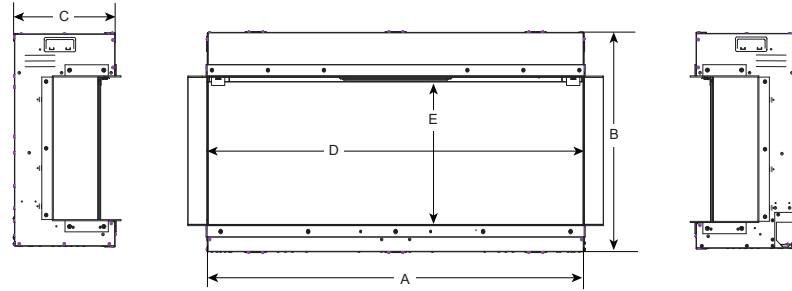

Side View

Front View

Side View

Scion



Model	BTU Output	Width (A)		Height (B)		Depth (C)		Viewing Area (D x E)
		Unit	Framing	Unit	Framing	Unit	Framing	
SF-SC43-BK	5,000	44-1/2" [1130]	45" [1143]	23-7/8" [606]	24-1/4" [616]	7-5/8" [194]	7-5/8" [194]	41-1/2" x 15" [1054 x 381]
SF-SC55-BK	5,000	56-1/2" [1435]	57" [1448]	23-7/8" [606]	24-1/4" [616]	7-5/8" [194]	7-5/8" [194]	53-1/4" x 15" [1353 x 381]
SF-SC78-BK	5,000	80" [2032]	80-1/2" [2045]	23-7/8" [606]	24-1/4" [616]	7-5/8" [194]	7-5/8" [194]	76-7/8" x 15" [1953 x 381]

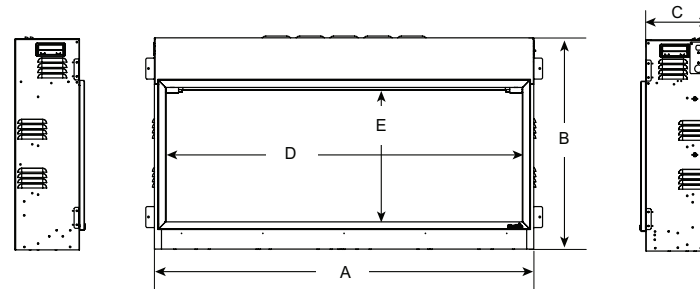

Side View

Front View

Side View

Allusion Platinum



Optional Boyd Build-Out Kit for 50" Allusion Platinum

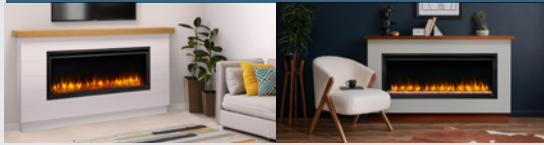

Model	BTU Output	Width			Height			Depth		Viewing Area (F x G)
		Front (A)	Back (B)	Framing	Front (C)	Back (D)	Framing	Unit (E)	Framing*	
SF-ALLP50-BK	5,000	52-5/16" [1329]	50-1/2" [1295]	51" [1 295]	20-7/16" [519]	19-3/8" [492]	19-3/4" [502]	5-5/8" [143]	2" x 6"	48" x 15" [1219 x 381]
SF-ALLP60-BK	5,000	62-5/16" [1583]	60-1/2" [1537]	61" [1549]	20-7/16" [519]	19-3/8" [492]	19-3/4" [502]	5-5/8" [143]	2" x 6"	58" x 15" [1473 x 381]
SF-ALLP72-BK	5,000	74-5/16" [1888]	72-1/2" [1842]	73" [1854]	20-7/16" [519]	19-3/8" [492]	19-3/4" [502]	5-5/8" [143]	2" x 6"	70" x 15" [1778 x 381]

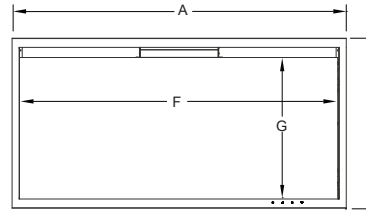

Front View

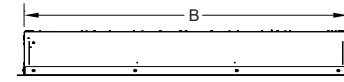

Top View

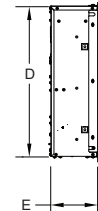

Side View

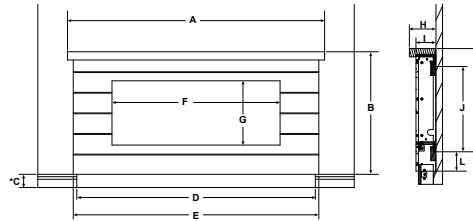

Front View

Side View

* Baseboard height if using toe kick.

Model	A	B	C	D	E	F
Modern Farmhouse BOK-MF-ALLP50	in. 78-1/8	37-1/4	1-1/2 - 5-1/2	72-1/2	74-1/4	51
Ready-to-Finish BOK-RTF-ALLP50	mm 1984	946	38 - 140	1842	1886	1295
Modern Farmhouse BOK-MF-ALLP60	in. 87-3/4	34-1/2	1-1/2 - 5-1/2	62-3/4	64-3/4	51
Ready-to-Finish BOK-RTF-ALLP60	mm 1721	876	38 - 140	1594	1645	1295

Model	G	H	I	J	K	L
Modern Farmhouse BOK-MF-ALLP50	in. 19-1/2	8	6-1/16	26-3/4	32-3/8	5-1/8
Ready-to-Finish BOK-RTF-ALLP50	mm 495	203	154	679	822	130
Modern Farmhouse BOK-MF-ALLP60	in. 19-1/2	7-1/2	6-1/16	26-3/4	31-1/4	3-1/4
Ready-to-Finish BOK-RTF-ALLP60	mm 495	191	154	679	794	83

Allusion Slim



Optional Crestline Kit for 50" Allusion Slim



Model	BTU Output	Width		Height		Depth	Viewing Area (F x G)
		Front (A)	Back (B)	Front (C)	Back (D)	Unit (E)	
SF-ALLS-40	5,000	40" [1015]	37-3/8" [949]	18-1/4" [465]	16-3/4" [425]	4-3/8" [113]	35-1/2" x 12"
SF-ALLS-50	5,000	50-1/2" [1283]	48" [1219]	18-1/4" [465]	16-3/4" [425]	4-3/8" [113]	46" x 12"
SF-ALLS-60	5,000	60" [1525]	57-3/8" [1457]	18-1/4" [465]	16-3/4" [425]	4-3/8" [113]	55-1/2" x 12"
SF-ALLS-72	5,000	72" [1830]	69-3/8" [1762]	18-1/4" [465]	16-3/4" [425]	4-3/8" [113]	67-1/2" x 12"

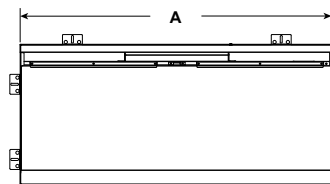

Front View

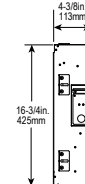

Side View

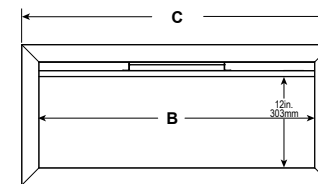

Front View with Front included

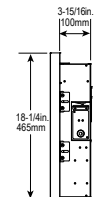

Side View with Front

Format



Model	BTU Output	Width (A)	Height (B)	Depth (C)	Depth (D)	Sides (E)	Viewing Area (F x G)
SF-FM50-WH	5,000	50" [1270]	23-5/16" [592]	7-7/8" [200]	9-7/8" [250]	6-7/8" [175]	36-1/16" x 12-5/8" [916 x 321]
SF-FM60-WH	5,000	59-7/8" [1520]	23-5/16" [592]	7-7/8" [200]	9-7/8" [250]	11-13/16" [300]	36-1/16" x 12-5/8" [916 x 321]

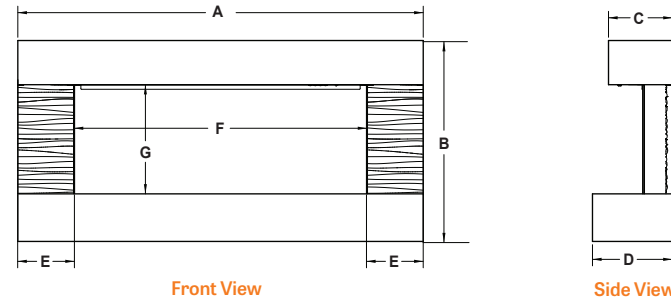

Model	BTU Output	Width (A)	Width (B)	Height (C)	Depth (D)	Depth (E)	Viewing Area (F x G)
SF-FM43-WH	5,000	37-13/16" [960]	43-5/16" [1100]	23-5/16" [592]	7-7/8" [200]	9-7/8" [250]	36-1/16" x 12-5/8" [916 x 321]

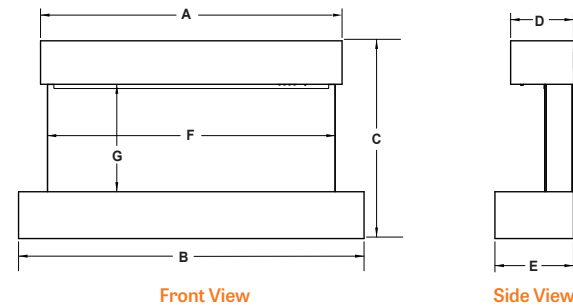

Outdoor Forum



Model	Width (A)	Height (B)	Depth (C)	Glass Size (D x E)
SF-OD43	46" [1168]	18-1/8" [460]	8-1/4" [210]	43-1/2" x 15-7/16" [1104 x 392]
SF-OD55	58" [1473]	18-1/8" [460]	8-1/4" [210]	55-1/2" x 15-7/16" [1410 x 392]

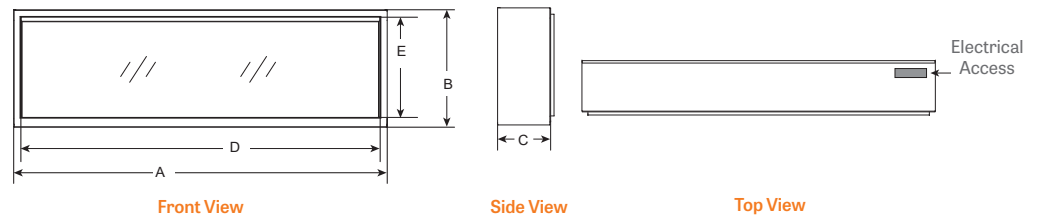



simplifire.com

Google, YouTube and Google Home are trademarks of Google LLC. Amazon, Alexa, and all related logos are trademarks of Amazon.com, Inc. or its affiliates.



OUR SUSTAINABILITY STORY

Our history of leadership in the hearth industry compels us to now lead the way in developing manufacturing practices that ensure our planet remains as durable, beautiful and long-lasting as our products. Find out how we are leading the industry in sustainable practices by scanning the code at left.



SFE-1011U-1224



[Learn More](#)

SimpliFire[®]
Fire Made Simple